

Note:

1.Type C -Pin out is the same as this drawing.

REV	ECN#	DESCRIPTION OF REVISION	DRAW BY DATE	CHECK BY DATE	APPROVE BY DATE
A3	ECN-210707	metal shell cover => Copper foil wrap	Lucas 07/16/21	Lucas 07/16/21	Ray 07/16/21

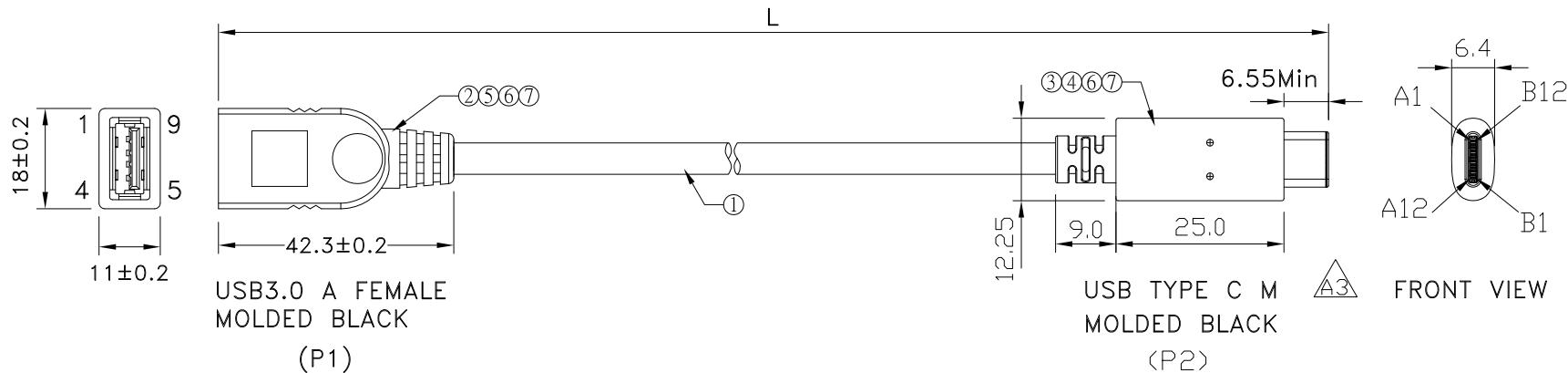

PIN OUT

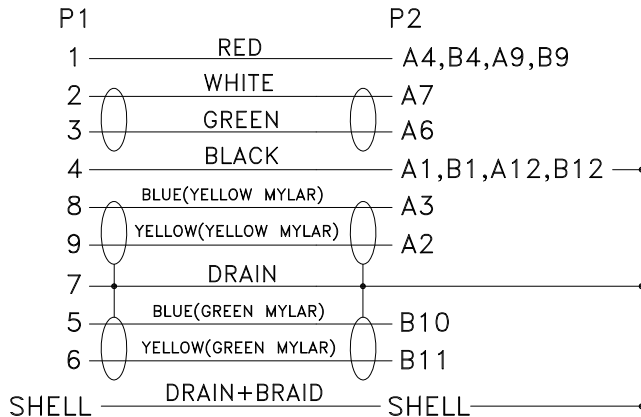

GTC
 DOC.CENTER.ISSUE
 FEB.29.2024
 ONLY FOR
 RELEASE

P/N	LENGTH
RR-CSAF-06GRA	152 ⁺²⁰ ₋₀
RR-CSAF-40GRA	1016 ⁺⁴⁰ ₋₀
RR-CSAF-120GRA	3048±50

TITLE						DRAWING NUMBER			REV.
USB TYPE C MALE STRAIGHT ANGLE TO USB 3.0 A FEMALE STRAIGHT ANGLE						RR-CSAF-XXGRA			A3
THIRD ANGLE PROJECTION	SIZE	SCALE	DRAW / DATE	CHECK / DATE	APPROVE / DATE	TOLERANCES		SHEET	
	B	1:1	Lucas 02/20/20	Lucas 02/20/20	Ray 02/20/20	X.X ± 0.5 X.XX ± 0.2	X.XXX ± 0.05 ANGLES ± 1°	mm 1/3	

USBFIREWIRE.com
 NOTICE OF PROPRIETARY PROPERTY:
 THE INFORMATION CONTAINED HEREIN IS THE PROPRIETARY PROPERTY OF GT CONTACT CD,LTD THE POSSESSOR AGREES TO THE FOLLOWING:
 (i) NOT TO REPRODUCE OR COPY IT
 (ii) NOT TO REVEAL OR PUBLISH IT IN WHOLE OR PART
 (iii) ALL RIGHTS RESERVED

1

2

3

4

REV	ECN#	DESCRIPTION OF REVISION	DRAW BY DATE	CHECK BY DATE	APPROVE BY DATE
A3	ECN-210707	metal shell cover => Copper foil wrap	Lucas 07/16/21	Lucas 07/16/21	Ray 07/16/21

ITEM	Part name	MATERIAL/FINISH	Q.ty
1	Cable	UL2725 (1P/30#+EAM)*2+(1P/30#)+(2C/24#)+AEB(AL)65% OD:5.0mm BLACK PVC JACKET	1
2	USB 3.0 AF	USB3.0 A TYPE FEMALE 9PIN MALE SOLDER TYPE	1
		PINS: 30u GOLD PLATED OVER NICKEL	
		INSULATOR: BLUE COLOR P.B.T UL 94V-0 RATED	
3	USB Type CM	SHELL: STEEL WITH GOLD FLASH	1
		USB TYPE C MALE SOLDER TYPE,RESISTOR(5.1KΩ) AND CAPACITOR(10nF 30V)	
		PINS: 30u GOLD PLATED OVER NICKEL	
		INSULATOR: BLACK COLOR P.B.T UL 94V-0 RATED	
4	inner Mold	HENKEL: A2035 94A	AR
		HD-PE	AR
5	inner Mold	BLACK PVC 45P	AR
6	Over Mold	Copper foil	AR

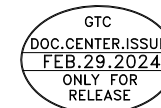

TITLE USB TYPE C MALE STRAIGHT ANGLE TO USB 3.0 A FEMALE STRAIGHT ANGLE					DRAWING NUMBER RR-CSAF-XXGRA			REV. A3
	B	1:1	Lucas 02/20/20	Lucas 02/20/20	Ray 02/20/20	X.X ± 0.5 X.XX ± 0.2	X.XXX ± 0.05 ANGLES ± 1°	mm 2/3
THIRD ANGLE PROJECTION	SIZE	SCALE	DRAW / DATE	CHECK / DATE	APPROVE / DATE	TOLERANCES		UNIT SHEET

NOTICE OF PROPRIETARY PROPERTY:
THE INFORMATION CONTAINED HEREIN IS THE PROPRIETARY PROPERTY OF GT Contact CO.,LTD THE POSSESSOR AGREES TO THE FOLLOWING:
(i) TO MAINTAIN THIS DOCUMENT IN CONFIDENCE
(ii) NOT TO REPRODUCE OR COPY IT
(iii) NOT TO REVEAL OR PUBLISH IT IN WHOLE OR PART
(iv) ALL RIGHTS RESERVED

1

2

3

4

1

2

3

4

REV	ECN#	DESCRIPTION OF REVISION	DRAW BY DATE	CHECK BY DATE	APPROVE BY DATE
A3	ECN-210707	metal shell cover => Copper foil wrap	Lucas 07/16/21	Lucas 07/16/21	Ray 07/16/21

P/N	LENGTH(mm)	PE BAG(Inch)	PACKAGE
RR-CSAF-06GRA	153 ⁺²⁰ ₋₀	5.5"*10	(1)
RR-CSAF-40GRA	1016 ⁺⁴⁰ ₋₀	5.5"*10	(2)
RR-CSAF-120GRA	3048±50	5.5"*10	(3)

PE BAG LABEL

RR-CSAF-XXGRA REV:XX
 LOT: XXXX
 Made in China

75mm

RR-CSAF-XXGRA REV:XX QTY:25PCS
 LOT: XXXX
 Made in China

25

RoHS LABEL

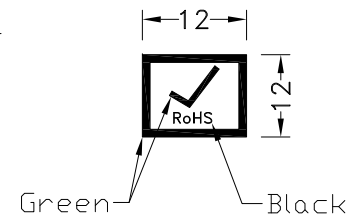

NOTES:PACK EACH CABLE IN A POLY BAG AND 25PCS IN A POLY BAG.

PACK(1)

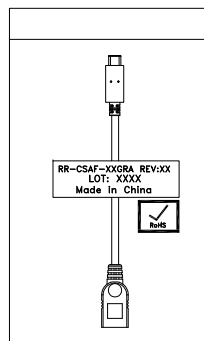

PACK(2)

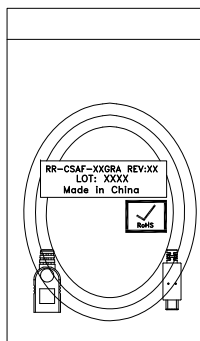

PACK(3)

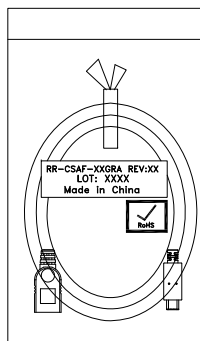

GTC
 DOC.CENTER.ISSUE
 FEB.29.2024
 ONLY FOR
 RELEASE

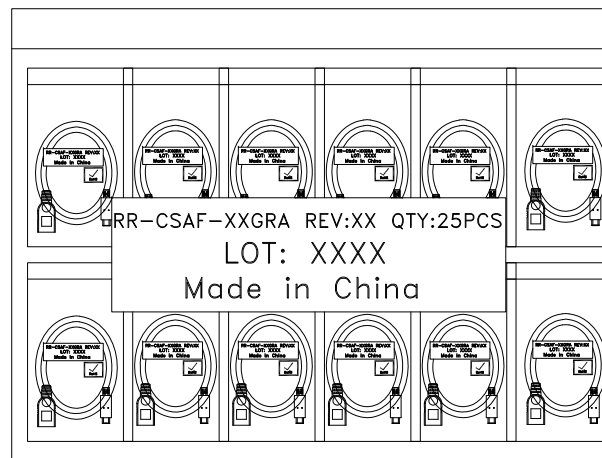

TITLE
 USB TYPE C MALE STRAIGHT ANGLE TO USB 3.0 A FEMALE STRAIGHT ANGLE

DRAWING NUMBER
 RR-CSAF-XXGRA
 REV.
 A3

	B	1:1	Lucas 02/20/20	Lucas 02/20/20	Ray 02/20/20	X.X ± 0.5 X.XX ± 0.2	X.XXX ± 0.05 ANGLES ± 1°	mm	3/3
THIRD ANGLE PROJECTION	SIZE	SCALE	DRAW / DATE	CHECK / DATE	APPROVE / DATE	TOLERANCES		UNIT	SHEET

NOTICE OF PROPRIETARY PROPERTY:
 THE INFORMATION CONTAINED HEREIN IS THE PROPRIETARY PROPERTY OF GT CONTACT CD,LTD THE POSSESSOR AGREES TO THE FOLLOWING:
 (i) TO MAINTAIN THIS DOCUMENT IN CONFIDENCE
 (ii) NOT TO REPRODUCE OR COPY IT
 (iii) NOT TO REVEAL OR PUBLISH IT IN WHOLE OR PART
 (iv) ALL RIGHTS RESERVED

1

2

3

4