

1

2

3

4

Note:

1.Type C AB面接點需跟圖面一致.

REV	ECN#	DESCRIPTION OF REVISION	DRAW BY DATE	CHECK BY DATE	APPROVE BY DATE
A4	ECN-190852	Change Wire&Mylar Color	Lucas 09/02/19	Lucas 09/02/19	Ray 09/02/19

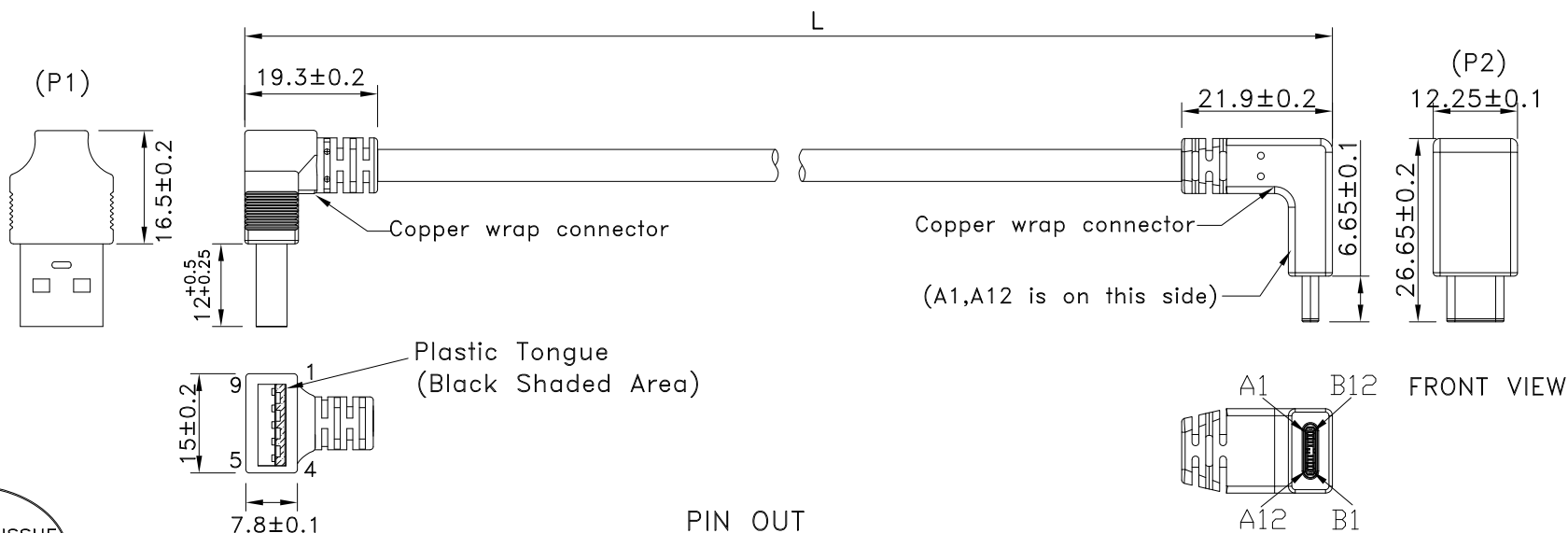

GTC  
DOC.CENTER.ISSUE  
SEP.03.2019  
ONLY FOR  
RELEASE

USB 3.0 A MALE  
RIGHT ANGLE DOWN  
MOLDED BLACK

PIN OUT

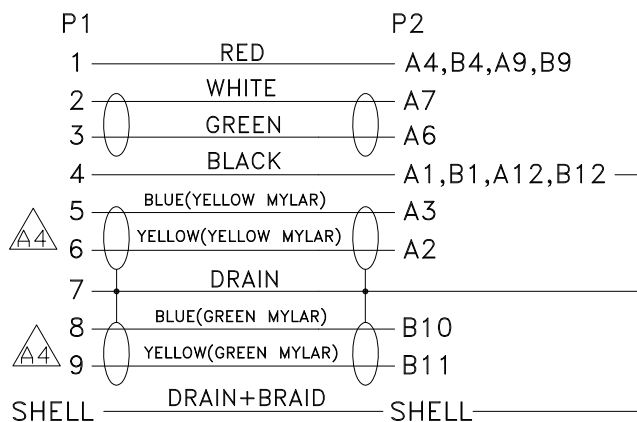

USB TYPE C M  
RIGHT ANGLE UP/DOWN  
MOLDED BLACK



P/N	LENGTH
RR-ADCV-05GRC	127 <sup>+20</sup> <sub>-0</sub>
RR-ADCV-10GRC	255 <sup>+20</sup> <sub>-0</sub>
RR-ADCV-15GRC	381 <sup>+30</sup> <sub>-0</sub>
RR-ADCV-25GRC	635 <sup>+30</sup> <sub>-0</sub>
RR-ADCV-40GRC	1016 <sup>+40</sup> <sub>-0</sub>

TITLE USB3.0 AM RIGHT ANGLE DOWN TO USB3.1 C TYPE MALE RIGHT ANGLE UP/DOWN					DRAWING NUMBER RR-ADCV-XXGRC			REV. A4	
DD NOT SCALE DRAWINGS	B	1:1	Lucas 12/28/15	Ray 12/28/15	Ray 12/28/15	X.X ± 0.5 X.XX ± 0.2	X.XXX ± 0.05 ANGLES ± 1°	mm	1/3
THIRD ANGLE PROJECTION	SIZE	SCALE	DRAW / DATE	CHECK / DATE	APPROVE / DATE	TOLERANCES		UNIT	SHEET

  
**USBFIREWIRE.com**

THE INFORMATION CONTAINED HEREIN IS PROPRIETARY AND CONFIDENTIAL TO RR BUSINESS VENTURES, LLC. THE POSSESSOR AGREES TO THE FOLLOWING

1. MAINTAIN THIS DOCUMENT IN CONFIDENCE
2. NOT TO REPRODUCE OR COPY IT
3. NOT TO REVEAL OR PUBLISH IT IN WHOLE OR PART

1

2

3

4

1

2

3

4

REV	ECN#	DESCRIPTION OF REVISION	DRAW BY DATE	CHECK BY DATE	APPROVE BY DATE
A4	ECN-190852	Change Wire&Mylar Color	Lucas 09/02/19	Lucas 09/02/19	Ray 09/02/19

\*\*\*CONSTRUCTION:

1.CABLE: \* UL2725 (1P/30#+EAM)\*2+(1P/30#)+(2C/24#)+AEB(AL)65% OD:5.0mm  
BLACK PVC JACKET.

\*\*\*CONNECTOR:

2.USB A/M: \* USB A "3.0" TYPE 9PIN MALE SOLDER TYPE. (SWEETRAY P/N:CHUSB3AM03B)  
\* PINS: 30u GOLD PLATED OVER NICKEL.  
\* INSULATOR: BLUE COLOR P.B.T UL 94V-0 RATED.  
\* SHELL: STEEL WITH GOLD FLASH .  
\* MOLDED: BLACK PVC 45P.

3.USB C/M: \* USB TYPE C MALE SOLDER TYPE.  
\* PINS: 30u GOLD PLATED OVER NICKEL.  
\* INSULATOR: BLACK THERMOPLASTIC UL 94V-0.  
\* SHELL: STEEL WITH GOLD FLASH.  
\* RESISTOR(56KΩ) AND CAPACITOR.  
\* MOLDED: BLACK PVC 45P.

4.TEST: \* CT: 2 ohm IS: 5M ohm DC300V 0.1S

5.PACKING: \* PACK EACH CABLE IN A POLY BAG AND 25PCS IN A POLY BAG.

6.MATERIAL: \* MATERIAL WITH RoHS GRADE.

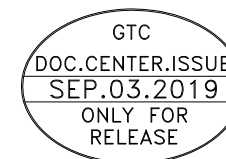

TITLE USB3.0 AM RIGHT ANGLE DOWN TO USB3.1 C TYPE MALE RIGHT ANGLE UP/DOWN					DRAWING NUMBER RR-ADCV-XXGRC			REV. A4
-------------------------------------------------------------------------------	--	--	--	--	---------------------------------	--	--	------------

DO NOT SCALE DRAWINGS	B	1:1	Lucas 12/28/15	Ray 12/28/15	Ray 12/28/15	X.X ± 0.5 X.XX ± 0.2	X.XXX ± 0.05 ANGLES ± 1°	mm	2/3
THIRD ANGLE PROJECTION	SIZE	SCALE	DRAW / DATE	CHECK / DATE	APPROVE / DATE	TOLERANCES		UNIT	SHEET

THE INFORMATION CONTAINED HEREIN IS PROPRIETARY AND CONFIDENTIAL TO RR BUSINESS VENTURES, LLC. THE POSSESSOR AGREES TO THE FOLLOWING  
1. MAINTAIN THIS DOCUMENT IN CONFIDENCE  
2. NOT TO REPRODUCE OR COPY IT  
3. NOT TO REVEAL OR PUBLISH IT IN WHOLE OR PART

1

2

3

4

1

2

3

4

REV	ECN#	DESCRIPTION OF REVISION	DRAW BY DATE	CHECK BY DATE	APPROVE BY DATE
A4	ECN-190852	Change Wire&Mylar Color	Lucas 09/02/19	Lucas 09/02/19	Ray 09/02/19

P/N	LENGTH(mm)	PE BAG(Inch)	PACKAGE
RR-ADCV-05GRC	127 <sup>+20</sup> <sub>-0</sub>	5.5"*10	(1)
RR-ADCV-10GRC	255 <sup>+20</sup> <sub>-0</sub>	5.5"*10	(2)
RR-ADCV-15GRC	381 <sup>+30</sup> <sub>-0</sub>	5.5"*10	(2)
RR-ADCV-25GRC	635 <sup>+30</sup> <sub>-0</sub>	5.5"*10	(2)
RR-ADCV-40GRC	1016 <sup>+40</sup> <sub>-0</sub>	5.5"*10	(2)

PE BAG LABEL

RR-ADCV-XXGRC REV:XX  
 LOT: XXXX  
 Made in China

RR-ADCV-XXGRC REV:XX QTY:25PCS  
 LOT: XXXX  
 Made in China

RoHS LABEL

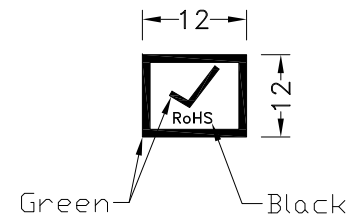

NOTES:PACK EACH CABLE IN A POLY BAG AND 25PCS IN A POLY BAG.

PACK(1)

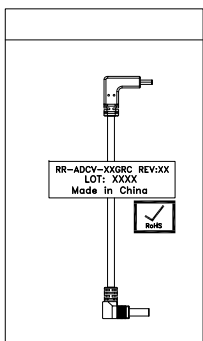

PACK(2)

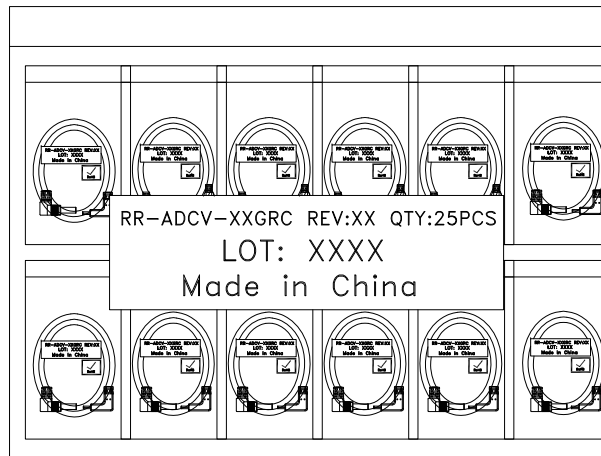
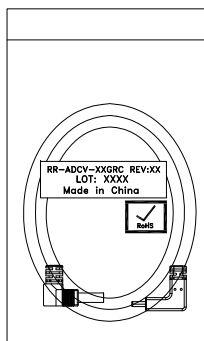

TITLE USB3.0 AM RIGHT ANGLE DOWN TO USB3.1 C TYPE MALE RIGHT ANGLE UP/DOWN					DRAWING NUMBER RR-ADCV-XXGRC			REV. A4
-------------------------------------------------------------------------------	--	--	--	--	---------------------------------	--	--	------------

THIRD ANGLE PROJECTION	SIZE	SCALE	DRAW / DATE	CHECK / DATE	APPROVE / DATE	TOLERANCES	UNIT	SHEET
	B	1:1	Lucas 12/28/15	Ray 12/28/15	Ray 12/28/15	X.X ± 0.5 X.XX ± 0.2	mm	3/3
						X.XXX ± 0.05 ANGLES ± 1°		

THE INFORMATION CONTAINED HEREIN IS PROPRIETARY AND CONFIDENTIAL TO RR BUSINESS VENTURES, LLC. THE POSSESSOR AGREES TO THE FOLLOWING

1. MAINTAIN THIS DOCUMENT IN CONFIDENCE
2. NOT TO REPRODUCE OR COPY IT
3. NOT TO REVEAL OR PUBLISH IT IN WHOLE OR PART

1

2

3

4